

nylex

METAL HOSE CABINET USER GUIDE



Kit Contents

- 1x Soft Touch Handle
- 1x 2M Tap to Reel Hose with Anti-leak Fittings attached
- 1x Water Inlet System with Connector
- 4x Legs
- 1x Metal Hose Cabinet
- 4x Leg Screws
- 1x Multi Function Spray Gun
- 1x Accessory Connector with Swivel
- 1x 25m Hose with Anti-leak Fittings attached

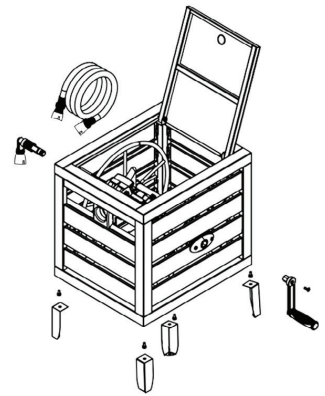

Step 1

Open Metal Hose Cabinet and remove the parts bag containing: Handle with screw, 2M Tap to Reel hose, Water Inlet System, Legs and Screws.

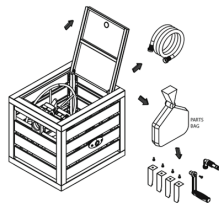

Step 2

CAUTION

Be careful not to scratch the unit during this step.

While holding the lid closed, rotate the Metal Hose Cabinet upside down and place on a clean, soft working surface. With the sides of the legs facing inward, attach a leg to each corner with a screw. Return the Metal Hose Cabinet to its normal standing position.

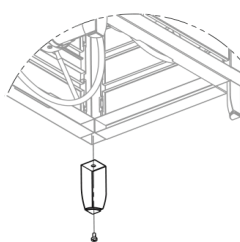

Step 3

Install the Handle on the right hand side of the Cabinet, using the supplied Handle Screw.

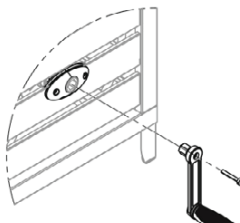

Step 4

Install the Water Inlet System on the left hand side of the Metal Hose Cabinet. This can be positioned to face forward, backward or downward. To install the Water Inlet System, pull the latch down (located on the underside of the Cabinet), insert in the desired orientation and lock by pushing the latch back into place. Make sure it is pushed all the way in, otherwise it may leak.

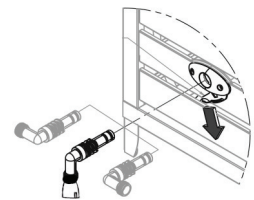

Step 5

Connect the end of the 2M Tap to Reel Hose to the Water Inlet System and the other end to your tap, ensuring both are tight in order to prevent leaking.

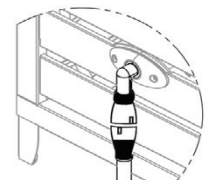

Storage Tips

Before rewinding the hose: turn water off at the tap and squeeze the trigger to release pressure from inside the hose. Turn the handle clockwise to reel the hose in.

If possible, the cabinet is best stored in a shaded area.

METAL HOSE CABINET USER GUIDE



HOSE INSTALLATION GUIDE (If installing your own hose)

Step 1

Verify that the Hose Guide is lined up with the Water Outlet inside the Cabinet. If necessary, unlock the Hose Guide by lifting the latch on top of the Guide and align it with the Water Outlet System. Re-lock the Hose Guide for use.

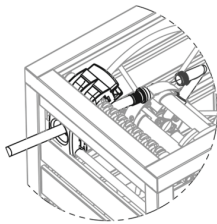

Step 3

Close the cover and wind the Hose back into the Cabinet by turning the Handle clockwise.

Step 2

Uncoil the Garden Hose to be installed and insert through the Hose Guide. Push the hose connector onto the coupling on the end of the Water Outlet.

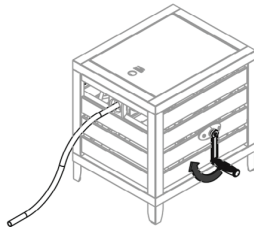

Step 4

Screw the Tap Connector onto the tap. Connect the end of the 2M Tap to Reel Hose to the tap.

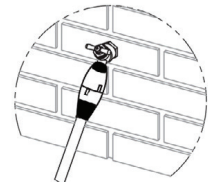

Guarantee

Ames Australasia warrants that this product will be free from defects in workmanship and materials for 3 years. If a defect in material or workmanship becomes evident during that period, Ames Australasia will, at its option, either; repair the product (or pay for the costs of repair of the product); replace the product; or refund to the customer the purchase price paid by the customer for the product. In the event of such a defect, the product should be returned to the place of purchase, together with proof of purchase for repair, replacement or refund. Any handling and transportation (and other expenses incurred in claiming under this guarantee) are not covered by this guarantee and will not be borne by Ames Australasia. The obligation of Ames Australasia under this guarantee is limited to the circumstances set out above and is subject to; the customer being able to evidence the acquisition of the product, the purchase price paid for the product and the relevant defect in materials or workmanship; the product not having been altered, tampered with or otherwise dealt with by any person in a manner other than as intended in respect of the relevant product; and the product not having been used or applied in a manner that is contrary to customary usage or application for the relevant product or contrary to any stated instructions or specification of Ames Australasia. Our goods come with guarantees that cannot be excluded under the Australian Consumer Law. You are entitled to a replacement or refund for a major failure and for compensation for any other reasonably foreseeable loss or damage. You are also entitled to have the goods repaired or replaced if the goods fail to be of acceptable quality and the failure does not amount to a major failure. The benefits given by this guarantee are in addition to the other rights and remedies which might be available to the customer under any law in relation to goods or services to which this guarantee relates.

For further information contact us on

Australia Free Call: 1800 335 019
New Zealand: 09 427 6042
www.nylex.com.au

AMES Australasia Pty Ltd

ABN 89 169 427 061
Level 1, 660 Doncaster Road,
Doncaster,
Victoria 3108. Australia